

# SIEMENS

Gigaset S675/S685 IP

Easy to  
install



CORDLESS HOME COMMUNICATION

# Gigaset

## Warning:

Read the safety precautions and the user guide on the CD before use.

Explain their contents and the potential hazards associated with using the telephone to your children.

- > Only use the mains adapters supplied, as indicated on the underside of the base station or charging cradle.
- > Only use the **recommended, rechargeable batteries**, i.e. never use a conventional (non-rechargeable) battery or other battery types as this could result in significant health risks and personal injury. For example, the batteries could explode. The phone could also malfunction or be damaged as a result of using batteries that are not of the recommended type.
- > Insert rechargeable batteries with the correct polarity, and use them in accordance with the user guide (polarity symbols can be seen in or on the handset's battery compartment).
- > Batteries should not be disposed of in general household waste. Observe the local waste disposal regulations, details of which can be obtained from your local authority or the dealer you purchased the product from.
- > The operation of medical appliances may be affected. Be aware of the technical conditions in your particular environment, e.g. doctor's surgery.
- > Do not hold the rear of the handset to your ear when it is ringing or when the handsfree function is activated. Otherwise you risk serious and permanent damage to your hearing. The handset may cause an unpleasant humming noise in hearing aids.
- > Do not install the base station or charging cradle in bathrooms or shower rooms. The handset, base station and charging cradle are not splashproof.
- > The charging cradle and base station are designed for use in enclosed dry rooms with a temperature range of +5 °C to +45 °C.
- > Do not use the phone in environments with a potential explosion hazard, e.g. paint shops.
- > Never expose the telephone to heat sources, direct sunlight or other electrical appliances.
- > Protect your Gigaset from moisture, dust, corrosive liquids and vapours.
- > If you give your Gigaset to someone else, make sure you also give them the user guide.
- > Please remove faulty base stations from use or have them repaired by our service, as they could interfere with other wireless services.
- > All electrical and electronic equipment must be disposed of separately from general household waste using the sites designated by local authorities.



If a product displays this symbol of a crossed-out rubbish bin, the product is subject to European Directive 2002/96/EC.

The appropriate disposal and separate collection of used equipment serve to prevent potential harm to the environment and to health. They are a requirement for the re-use and recycling of used electrical and electronic equipment.

For further information on disposing of your used equipment, please contact your local authority, your refuse collection service or the dealer you purchased the product from.

## Warning:

When the keypad lock is active, you cannot call emergency numbers.

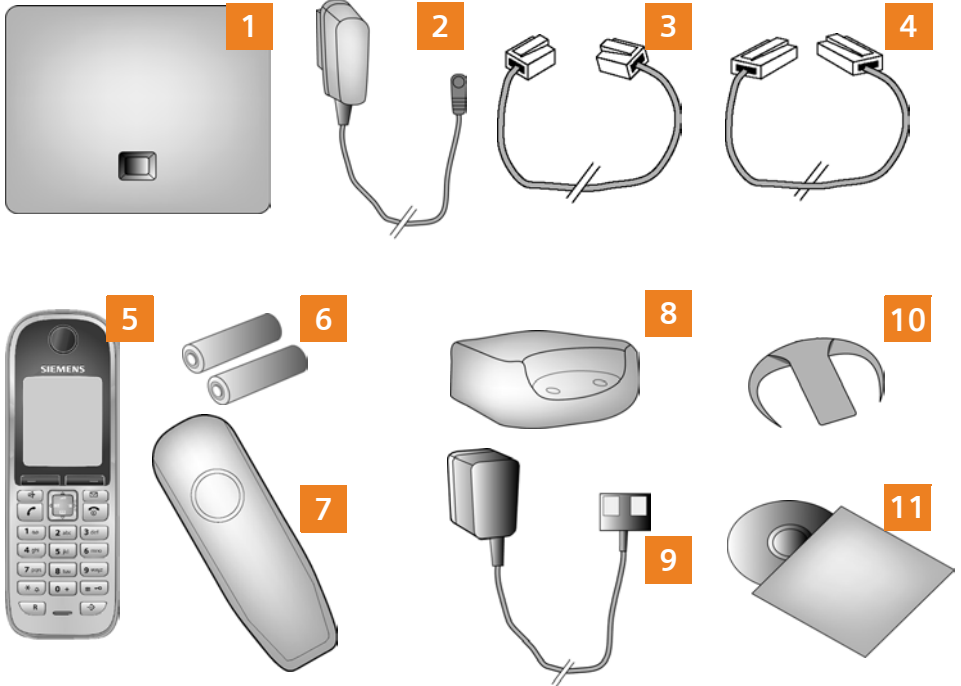

- 1 Gigaset S675/S685 IP **base station**
- 2 Mains adapter for connecting the base station to the mains power supply
- 3 Phone cord for connecting the base station to the fixed line network
- 4 Ethernet (LAN) cable for connecting the base station to the router (LAN/Internet)
- 5 Gigaset S67H/S68H **handset**
- 6 Two batteries for the handset (uncharged)
- 7 Battery compartment cover for the handset
- 8 Handset **charging cradle**
- 9 Mains adapter for connecting the charging cradle to the mains power supply
- 10 Belt clip for the handset
- 11 CD with the **user guide** for your Gigaset.

If the firmware for your base station is updated, the user guide will also be updated and made available for download on the Internet at [www.gigaset.com](http://www.gigaset.com).

# 4 Keys and functions on the handset



## Display keys:

Start function displayed to the left or right of the bottom display line.



## Handsfree key:

Switch between earpiece and handsfree mode (key lights up)



## Talk key:

After entering number: start dialling via VoIP/fixed line network (press briefly/press and hold); accept call



## Control key:

Open menu (press right); open directory (press down arrow); open list of online directories (press and hold down arrow); scroll through menus (press up/down); navigate in text



## Message key:

Open calls and messages lists; flashes: new message/new call



## End call key, on/off key:

End call, cancel function (press briefly); return to idle status (press and hold), turn handset on/off (press and hold)



## Fast access key (press and hold):

Listen to messages on the network mailbox or on the integrated answer machine



**\* key:** Ringer on/off (press and hold)



**# key:** Keypad lock on/off (press and hold)



**Recall/pause key** (fixed line network)



Open **call-by-call list** (fixed line network)

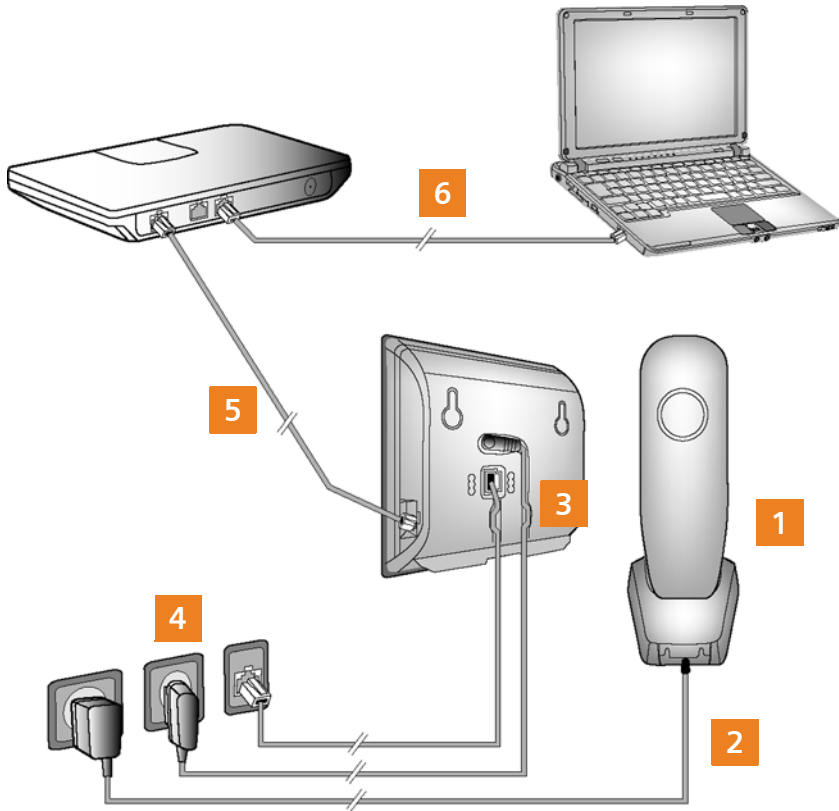

- 1 Prepare the handset: insert the batteries
- 2 Connect the charging cradle to the mains power supply and charge the batteries
- 3 Connect the phone cord and power lead to the base station
- 4 Connect the base station to the fixed line network and the mains power supply
- 5 Connect the base station to the Internet and connect the base station to the router (Connection via router and modem or via router with integrated modem)
- 6 PC in LAN (optional) – for advanced configuration of the Gigaset S675/S685 IP base station

## 1 Inserting the supplied batteries and closing the battery cover



- > Check the polarity when inserting the batteries (see symbols in or on the battery compartment).
- > Only use the recommended rechargeable batteries.

Once the batteries have been inserted, the handset turns on automatically.

- > First, align the notches on the side of the battery cover with the protrusions on the inside of the housing.
- > Then press the cover until it clicks into place.

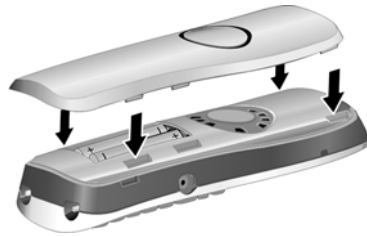

> The display is protected by a plastic film. Please remove the protective film!

## 2 Connecting the charging cradle and charging the batteries

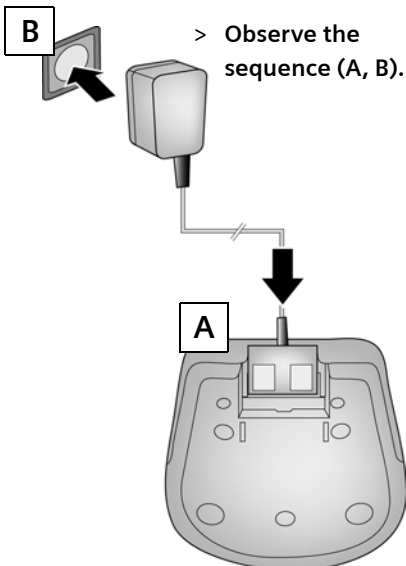

> Observe the sequence (A, B).



- > Place the handset in the charging cradle and wait until the batteries are fully charged.

- > Do not put the handset back in the charging cradle until the batteries are fully discharged through use.
- > After the first battery charge **and** discharge, replace your handset in the charging cradle after every call.
- > The battery charging status is displayed in the idle display: (flat to full).

## 3 Connecting the phone cord and power lead to the base station

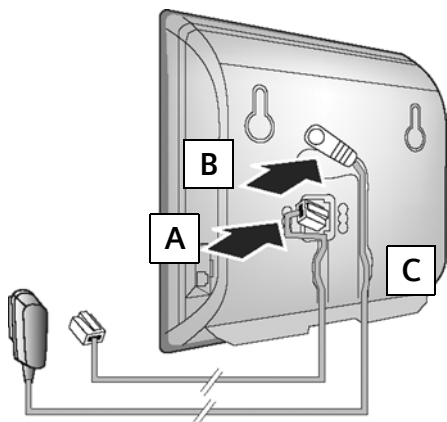

- A** Insert the phone cord into the lower connection socket at the rear of the base station.
- B** Insert the power lead of the mains adapter into the upper connection socket at the rear of the base station.
- C** Insert both cables into their respective cable recesses.

Only use the supplied phone cord and the supplied mains adapter.

## 4 Connecting the base station to the fixed line network and mains power supply

- A** Insert the phone cord into the fixed line network connection socket.
- B** Then insert the mains adapter into the mains socket.

Keep the mains adapter **plugged in at all times** for operation, as the phone does not work without mains connection.

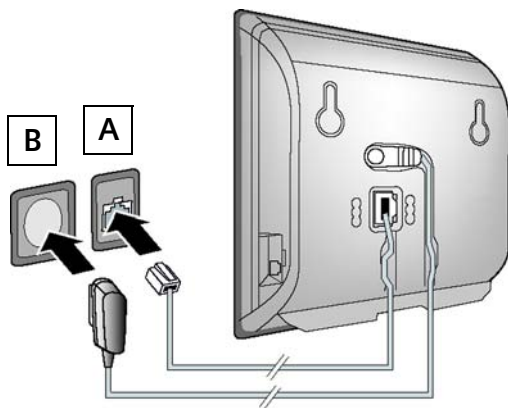

You can now use your phone to make calls via the fixed line network.  
The local answer machine is activated.

## 5 Connecting the base station with the router (Internet)

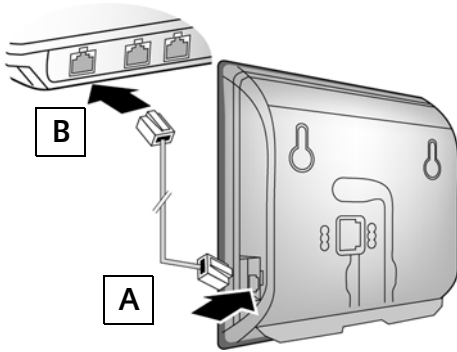

- A** Connect one Ethernet cable plug to the LAN socket at the side of the base station.
- B** Insert the second Ethernet cable plug into a LAN socket on the router.

Use the Ethernet cable supplied.

As soon as the cable connecting the phone and router is plugged in, the key lights up on the front of the base station (paging key).

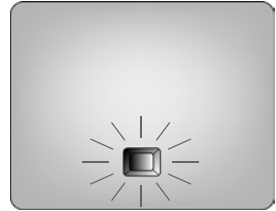

## 6 Connecting the PC to the router (optional)

You can make further settings on the phone's base station at a later stage, using a PC connected to the phone via the router.

- > Connect the PC network connection to a free LAN socket on your router.



## Precondition for the following steps:

Before you can use the Internet (VoIP) to phone any other subscribers on the Internet, the fixed line network or the mobile phone network, you need a VoIP account.

- > Set up a VoIP account with a VoIP provider.
- > Have the VoIP account data you received from your VoIP provider to hand.

## You will need:



- > Your authentication name and your password\*
- > For some VoIP providers, your user name

### Please note:

- > The procedure below requires that your phone is automatically assigned an IP address by the router (i.e. DHCP is enabled on router and phone).

In **exceptional cases** (e.g. if DHCP is not enabled on the router) you will have to assign a static IP address to the base station for LAN access. You must enter this IP address on the handset before carrying out the following steps. Further information can be found in the user guide on the supplied CD.

The following handset menu can be used to make the entry:

 (press right) →  → Base → Local Network

- > VoIP should be set as the standard connection for your phone (default setting). If the connection to your provider's VoIP server cannot be established due to incorrect/incomplete data, you will immediately receive messages to that effect.

\*) Automatic configuration:

If your provider supports "automatic configuration", you will receive an "auto configuration code" instead of an authentication name and password.

VoIP configuration with an auto configuration code is described in the user guide on the accompanying CD.

After configuration, please proceed as described in section **12**.

## 7 Starting the configuration process

When your handset is sufficiently charged (approx. 20 minutes after you have placed it in the charging cradle), the message key  on the handset flashes.



> Press the message key on the handset.

## 8 Starting the connection assistant, entering the PIN

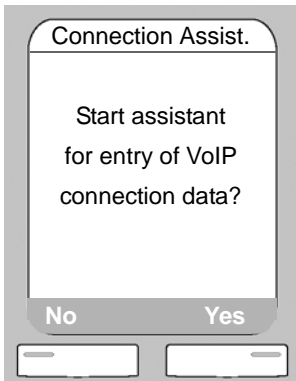

> Press the display key below **Yes**.

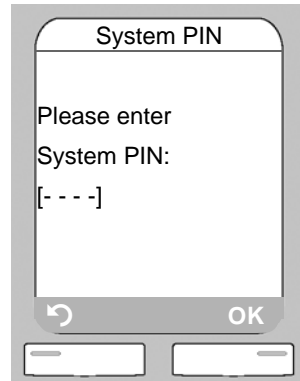

> Using the number keys, enter the base station's system PIN. By default, the PIN is "0000".

If the connection assistant does not start properly, you can start it via the following handset menu:

 (press right) →  → Telephony → Connection Assist.

## 9 Selecting a provider and loading provider data to the base station



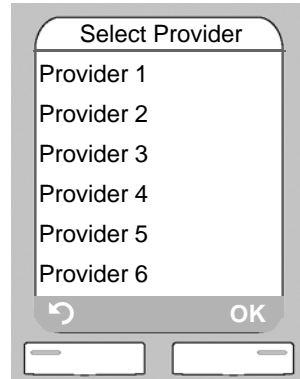

- > Select your country with the control key  (press down arrow).
- > Press the display key below **OK**.



- > Select your provider with the control key  (press down arrow).
- > Press the display key below **OK**.

If your provider does not appear in the list, you have the following options:

- > Press the display key  twice and proceed as described under **10**. You will only be able to use the VoIP connection once you have added the provider-specific data to the access data using the Web configurator. Your VoIP provider will supply you with this data.
- > Exit the connection assistant by pressing and holding the end call key  and use the Web configurator to enter your provider data and VoIP account data. You can then create your Gigaset.net entry directly in the Gigaset.net directory.

You will find more information on the Web configurator and the Gigaset.net phonebook in the user guide on the enclosed CD.

## 10 Entering VoIP account data



- > Using the number keys, enter the authentication name (user identification) that you received from your VoIP provider. This entry is case-sensitive.
- > Press the display key below **OK**.

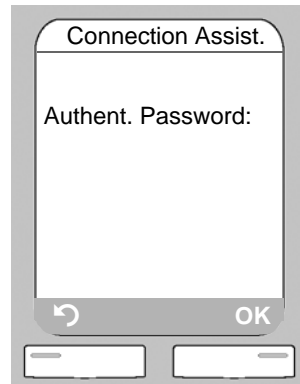

- > Using the number keys, enter the authentication password that you received from your provider. This entry is case-sensitive.
- > Press the display key below **OK**.

- > To switch between upper and lower case and digits, press the **# ->** key (several times if necessary).
  - > Characters entered incorrectly can be deleted using the left display key below **<C**. The character to the left of the cursor will be deleted.
  - > You can navigate within the input field using the control key **⏪ ⏩** (press right/left).
- > Depending on your provider, you may now be prompted to enter a user name. Enter it as described above.

If you have made all the required entries, the message "Connection data complete" will appear briefly on the display.

You can enter five additional VoIP accounts (VoIP phone numbers) via your base station's Web configurator at a later stage. Further information can be found in the user guide on the enclosed CD.

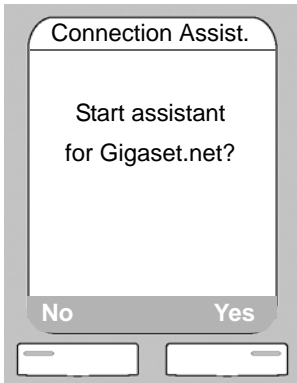
**11** Entering your name in the Gigaset.net directory

> Press the display key below **Yes**.



- > Using the number keys, enter the name that you would like to be listed under in the Gigaset.net directory.
- > Press the display key below **OK**.

If an entry with this name already exists, the message **Nickname already exists!** will be displayed. You will be prompted to enter a name again.

If an entry in the Gigaset.net directory is successful, the message **"Your user name is successfully added to Gigaset.net!"** will be shown.

If the attempt to create the entry fails (e.g. because the phone is not connected to the Internet), a message to this effect is displayed briefly.

You can then create the entry later via the Gigaset.net directory.

## 12 Completing the VoIP settings

If all the settings are correct and if the phone can establish a connection to the VoIP server, then the internal name of the handset will be displayed (example):

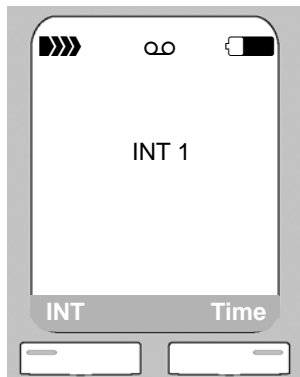

You can now use your phone to make calls via the fixed line network and the Internet. Callers can contact you on your fixed line network number, your Gigaset.net number or your VoIP number.

To ensure that you can always be reached via the Internet, the router must be permanently connected to the Internet.

## 13 Testing your VoIP connection

If, instead of the name, a message is displayed, you can test the base station's connection to the Internet, e.g. by calling the Gigaset.net echo service:

> Enter one of the following phone numbers:

**12341#9** (English)

**12342#9** (Dutch)

**12343#9** (Italian)

**12344#9** (French)

**12345#9** (German)

**12346#9** (Spanish)

> Press the talk key .

> When prompted, speak into the microphone on the handset.

If you hear your own voice, your base station is connected to the Internet.

If you do not hear your voice, check your phone and router settings.



In the user guide on the enclosed CD, you will find detailed information about setting up and operating your phone, as well as possible solutions to frequently asked questions and common problems.

## Making calls

**Precondition:** You have not changed your phone's default settings.





- > Enter a phone number using your handset's number keys.  
Please note that you must always dial the area code for calls via VoIP, even with local calls (depends on provider).
- > **Briefly** press the talk key  if you want to make a call via **VoIP**.

Or

- > Press and **hold** the talk key  if you want to make a call via the **fixed line network**.

## Answer machine operation

### Activating/deactivating the answer machine



- > Press right on the control key  to open the menu.
- > Enter     using the handset's number keys.  
Ans Machine is selected in the display.

The answer machine is activated if  is displayed after Ans Machine.

The answer machine is deactivated if  is displayed.





- > Press the display key below **OK** to change the status of the answer machine (on/off).

### Playing back messages

- > Press the message key . Select the Ans M.: list using the control key  (press down arrow) and press the display key below **OK**.

Message playback is started.

You can control message playback via the number keys on your handset:

-  Go to the start of the current message.  
Press repeatedly to go to the previous messages.
-  Pause/resume playback.
-  Skip to next message.
-  Mark current message as "new".  
Start playback of the following message.
-  Delete current message.

You can get assistance easily when you have technical questions or questions about how to use your device by using our online support service on the Internet at:

[www.gigaset.com/customercare](http://www.gigaset.com/customercare)

This site can be accessed at any time wherever you are. It will give you 24/7 support for all our products. It also provides a list of FAQs and answers plus user guides for you to download. You will also find frequently asked questions and answers in the **Questions and Answers** section of this user guide in the appendix.

If the device needs to be repaired, please contact one of our Customer Care Centers:

Abu Dhabi . . . . .	97 12 62 23 800	Jordan . . . . .	00962 6 5625460/1/2
Argentina . . . . .	0800-888-9878	Kuwait . . . . .	00965-2464993
Australia . . . . .	1300 665 366	Latvia . . . . .	7 50 11 18
Austria . . . . .	05 17 07 50 04 (0,065 Euro/Min.)	Lebanon . . . . .	00961-1236110
Bahrain . . . . .	97 31 73 11 173	Luxembourg . . . . .	40 66 61 56 40
Belgium . . . . .	0 78 15 66 79	Malaysia . . . . .	603 77124304
Bosnia Herzegovina . . . . .	033 276 649	Malta . . . . .	+353 21 4940 632
Brazil . . . . .		Mexico . . . . .	01800 999 4442738 (01800 999 Gigaset)
Grande Capitais e Regiões Metropolitanas: . . . . .	4003 3020	Netherlands . . . . .	0900-3333102 (0,25 Euro/min.)
Demais localidades: . . . . .	R\$ 0,14 (US\$ 0,069)	New Zealand . . . . .	08 00 27 43 63
	0800 888 3020	Norway . . . . .	22 70 84 00
	R\$ 0,20 (US\$ 0,098)	Oman . . . . .	96 82 47 09 281
Bulgaria . . . . .	02 873 94 88	Poland . . . . .	0 801 140 160
Canada . . . . .	866 247 8758	Portugal . . . . .	(351) 808 781 223
China . . . . .	0 21 400 670 6007 (RMB 0.11)	Romania . . . . .	+4.021.529.7114.
Croatia . . . . .	01 / 2456 555 (0,23 Kn)	Russia . . . . .	8 (495) 228 1312
Czech Republic . . . . .	233 032 727	Serbia . . . . .	0800 222 111
Denmark . . . . .	35 25 86 00	Singapore . . . . .	6735 9100
Dubai . . . . .	97 14 39 69 944	Slovak Republic . . . . .	02 59 68 22 66 (4,428 sk)
Egypt . . . . .	202 7623441	Slovenija . . . . .	0 14 74 63 36
Finland . . . . .	09 23 11 34 25	South Africa . . . . .	08 60 10 11 57
France . . . . .	01 56 38 42 00 (Appel national)	Spain . . . . .	902 103935
Germany . . . . .	01805 333 222	Sweden . . . . .	08 750 99 11
(0,14 Euro/Min. aus dem Festnetz der Deutschen Telekom.		Switzerland . . . . .	0848 212 000 (0,08 SFr./Min.)
Für Anrufe aus den Mobilfunknetzen können abweichende Preise gelten)		Taiwan . . . . .	02 266 24343
Greece . . . . .	801 1000 500 (0,026 Euro)	Thailand . . . . .	02 722 1118
Hong Kong . . . . .	2763 0203	Turkey . . . . .	0216 459 98 59
	2389 7285	Ukraine . . . . .	+380-44-451-71-72
Hungary . . . . .	06 14 71 24 44 (27 Ft)	United Arab Emirates . . . . .	0 43 66 03 86
India . . . . .	Please refer to your local warranty card	United Kingdom . . . . .	0 84 53 67 08 12
Ireland . . . . .	18 50 77 72 77	USA . . . . .	1-866 247-8758
Israel . . . . .	1 700 700 727		(toll free)
Italy . . . . .	199.15.11.15	Vietnam . . . . .	1900 545 416

Please address any questions about DSL access and VoIP access to the respective service provider.

Please have your record of purchase ready when calling.

Replacement or repair services are not offered in countries where our product is not sold by authorised dealers



## Authorisation

This device is intended for analogue phone lines in your network.

Voice over IP telephony is possible with an additional modem via the LAN interface.

Country-specific requirements have been taken into consideration.

We, Gigaset Communications GmbH, declare that this device meets the essential requirements and other relevant regulations laid down in Directive 1999/5/EC.

A copy of the 1999/5/EC Declaration of Conformity is available at this Internet address:  
[www.gigaset.com/docs](http://www.gigaset.com/docs).



Bluetooth : Qualified Design Identity  
The Bluetooth QD ID for your Gigaset S68H is: B012741.

Version: 30-10-2008



A31008 - M1915 - R201 - 2 - PG43

Issued by

Gigaset Communications GmbH, Schlavenhorst 66, D-46395 Bocholt  
Gigaset Communications GmbH is a trademark licensee of Siemens AG

© Gigaset Communications GmbH 2008

All rights reserved. Subject to availability. Rights of modifications reserved.

[www.gigaset.com](http://www.gigaset.com)